



# ELITE FORCE

SR10

AIRSOFT RIFLE / cal. 6 mm BB





### DESCRIPTION



### OPERATION



### MAINTENANCE



### SAFETY INSTRUCTIONS

You should be fully familiar with the proper and safe handling of your gun. The basic principles of gun safety require you to always apply the following rules when handling the firearm.

- Always treat a gun as if it was loaded.
- Always put the safety of a gun to “safe” when loading it so that there can be no unintentional discharge.
- Keep your finger away from the trigger. It should be straight and should rest on the trigger guard.
- Only use the kind of projectiles suitable for your gun.
- Always keep the muzzle pointed in a safe direction.
- This gun may only be discharged in your own house, on authorized shooting ranges and inside enclosed private property. It is to be made sure that no projectile can leave the enclosed property.
- Keep the danger area of the projectile in mind.
- Never transport a loaded gun. Only load your gun when you intend to fire it.
- Never aim your airgun at persons or animals. Avoid ricochets. Never fire at smooth, hard surfaces or water.
- Before you discharge your gun, make sure that target and surrounding area are safe.
- Always make sure that the gun is not loaded when you transport it or take it from another person.
- Make sure that you always have full control over the muzzle of your gun, even if you stumble or fall down.
- Safety shooting glasses should always be worn when firing the gun.
- Always store your gun in a safe place and in unloaded condition. Unauthorized persons (persons not familiar with the use of guns, children) must not have access to it. Ammunition is to be kept in a separate place.
- This gun and its instruction manual may only be passed on to persons
  - who are fully familiar with its use and
  - who have reached the legally stipulated minimum age in the respective country.
- Modifications or repairs of guns are only to be effected by authorized agencies or by a skilled gunsmith.
- Never leave a loaded gun unattended.
- Only unloaded guns are to be handed over to another person.

### REPAIR

A gun that does not work properly is dangerous. Do not attempt to repair this pistol if it needs service. Incorrect assembly could lead to dangerous malfunctions.

**Caution: Repairs should only be completed by Umarex authorized centres.**



## SAFETY INSTRUCTIONS | WARRANTY



### CAUTION

For your own safety and the safety of others, carefully read these instructions before using this gun. Buyers and owners must observe all rules concerning the use and ownership of air guns. Modifying this gun may result in a change of its classification under guns law and is therefore prohibited. In such cases the manufacturer's warranty will immediately become void.



### WARNING

Do not brandish or display this airgun in public - it may confuse people and may be a crime. Police and others may think this airgun is a firearm. Do not change the coloration and markings to make it look more like a firearm. That is dangerous and may be a crime.

## WARRANTY

During the legal warranty period, which begins on the date of purchase, Umarex will repair or replace your gun at no charge provided the defect was not caused by you. Return your gun to an authorized dealer along with a description of the problem and proof of purchase.

The air guns manufactured by UMAREX GmbH & Co. KG are made according to the regulations of the PTB (Physikalisch-Technische Bundesanstalt), German federal law, the CIP regulations and the technical know-how of UMAREX GmbH & Co. KG.

We will not assume any liability whatsoever if this product is exported to territories outside of Germany and as a consequence does not comply with domestic legal requirements of these territories. It will be the sole responsibility of the importer to ensure compliance with local laws and regulations.

## TECHNICAL DATA

|                       |                              |
|-----------------------|------------------------------|
| Item No.              | 2.6425-1                     |
| System / Power Source | Mechanical Airsoft           |
| Caliber / Ammo        | cal. 6 mm BB                 |
| Capacity              | 32 rounds (BBs)              |
| Energy                | 1,6 J                        |
| Velocity              | up to 125 m/s with 0,20 g BB |
| Color                 | black                        |
| Safety                | manual                       |
| Barrel length         | 570 mm                       |
| Dangerous area up to  | 200 m                        |
| Weight                | 3250 g                       |
| Length                | 1130 mm                      |



## DESCRIPTION

EN

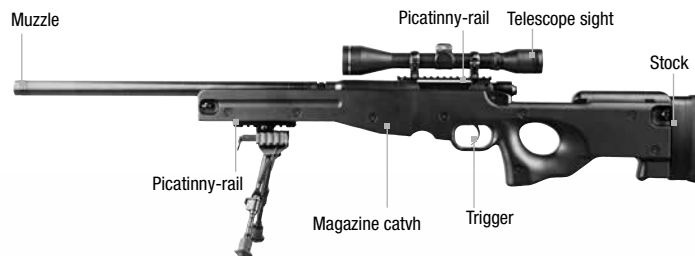

## SHIPMENT

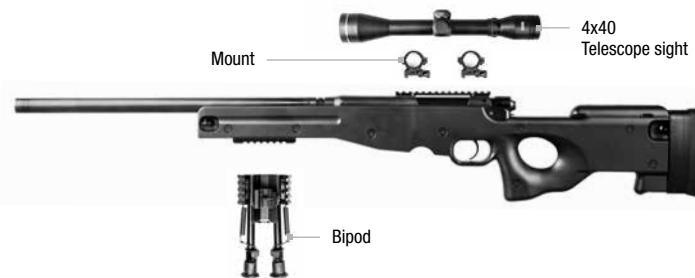



## SAFETY

### ⚠ CAUTION

- Only handle your gun in its safe condition.
- Always make sure that the muzzle points in a safe direction.



SAFE

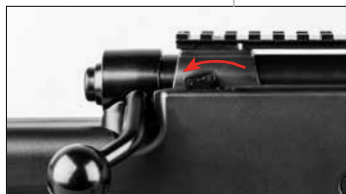

FIRE

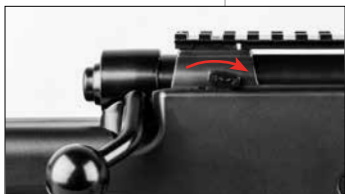

## TELESCOPIC SIGHT MOUNT

EN



1.

Screw on telescopic sight mount



2.

Unscrew



3.

Insert



4.

Screw tight

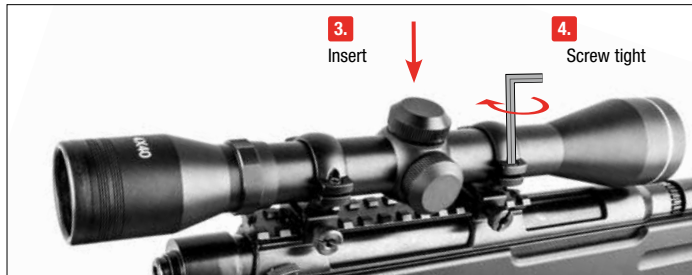



## MOUNTING OF BIPOD

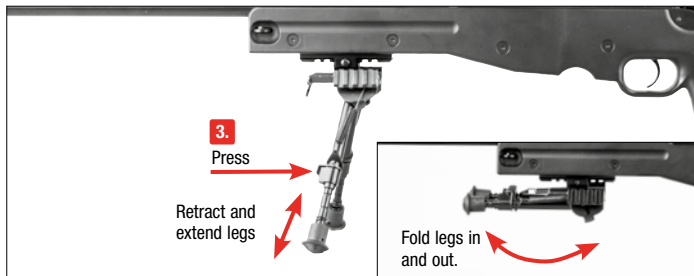

## LOADING THE MAGAZINE

EN

### ⚠ CAUTION



Only use flawless BBS. Never use the following BBS: **1** diameter larger than 6mm, **2** with edges, **3** both halves not aligned, **4** used, soiled. Warranty expires if non-recommended BBS are used. It's recommended to use precision BBS from Umarex/Walther. To ensure proper operation of the magazine, protect it from dirt and dust.

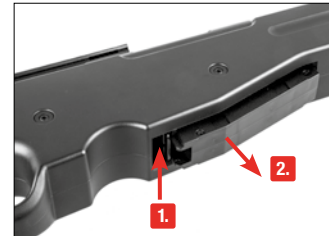

 **CAUTION**

Please do not switch the fire selector while pulling the trigger. This causes severe damage to your gun.

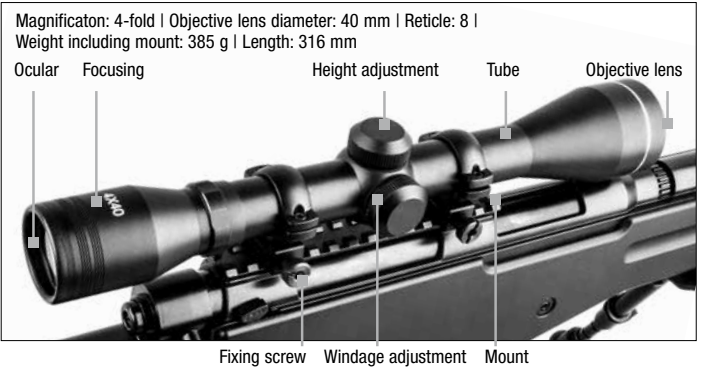
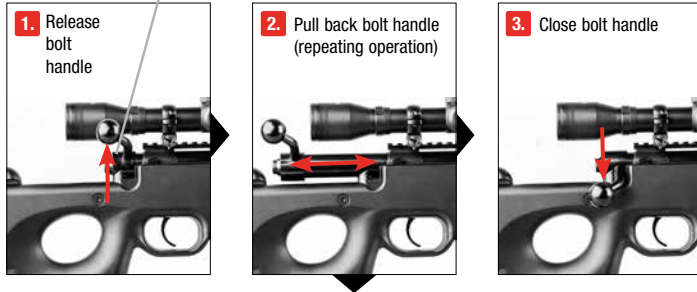

1X CLICK - 0,7 mm/10 m / (0.025 inch/10 yards)

**HEIGHT ADJUSTMENT**

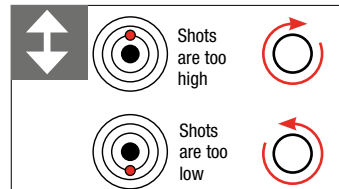

**WINDAGE ADJUSTMENT**





## ADJUSTABLE SHOOT UP

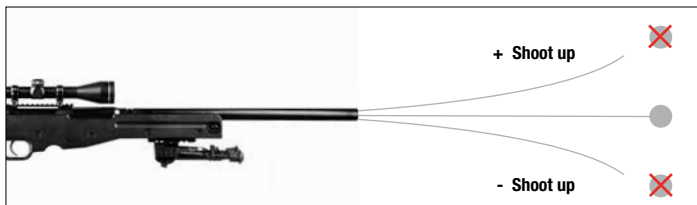
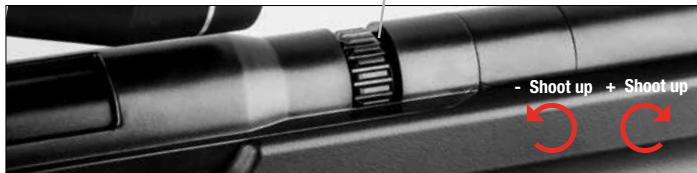

## SIGHTS

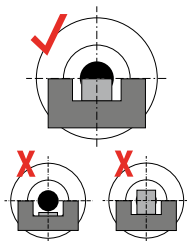
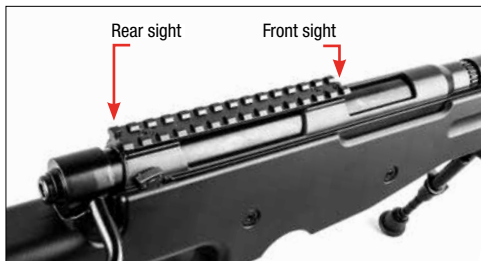

## BARREL CLEANING

EN



### CAUTION

- Adjust the shoot up in normal position, before cleaning the weapon.
- Unload the gun before cleaning it.
- Do not force the rod into the barrel, as this could cause damage.
- Occasionally clean the metal parts on the outside. Use a cloth which has been slightly dampened with some gun oil.
- Never drip silicone oil directly into the barrel.

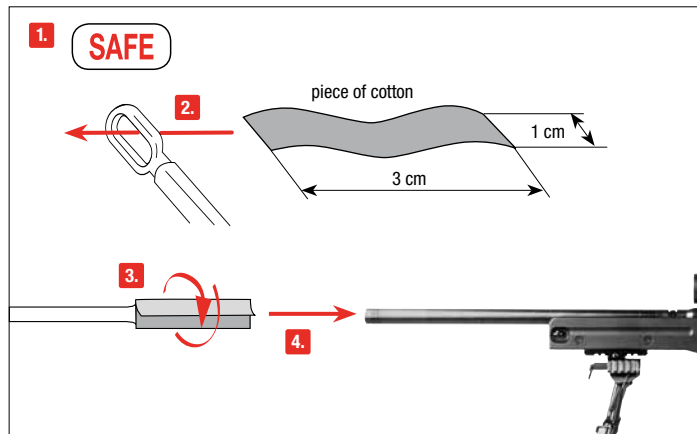

Put the safety on "safe". Prepare a thin rod with a length of approx. 60 cm. Attach a piece of cotton fabric to its end and clean the barrel with some silicone oil.